

Technical
Drawing

Desenho
Técnico

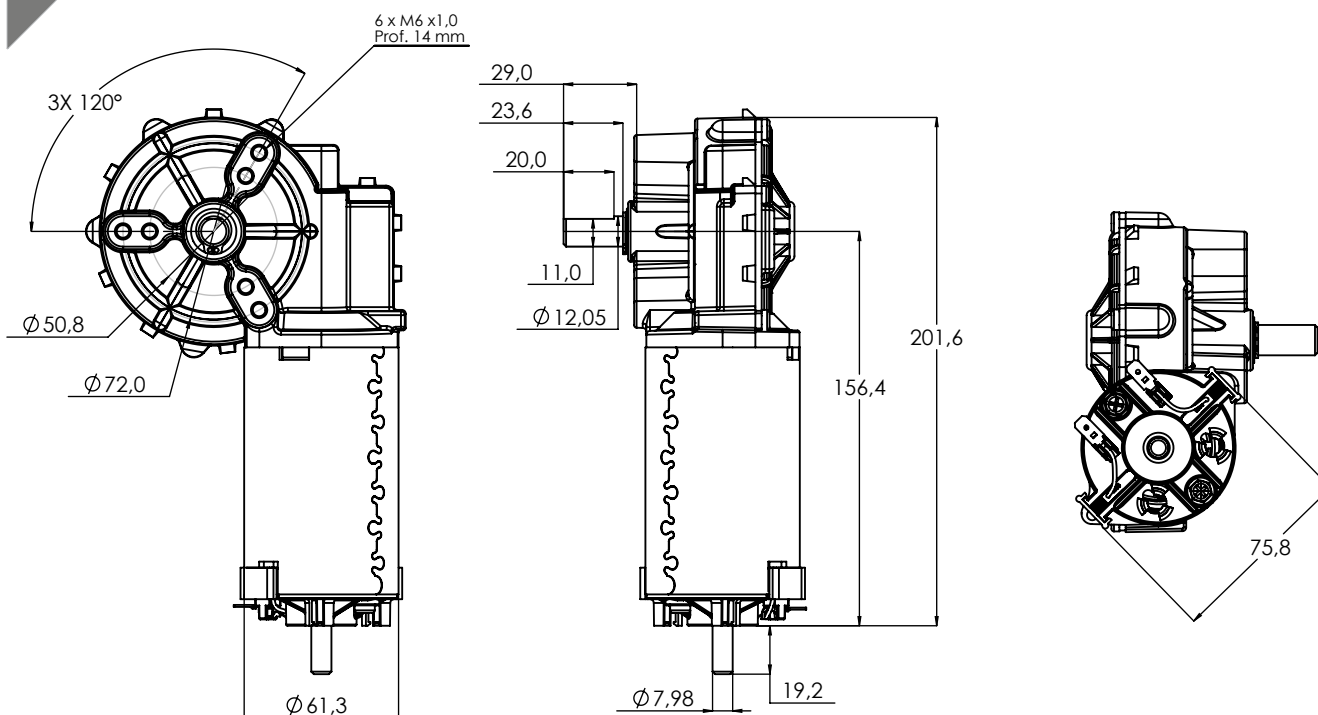

Technical
Specification

Especificação
Técnica

Imagem
Ilustrativa

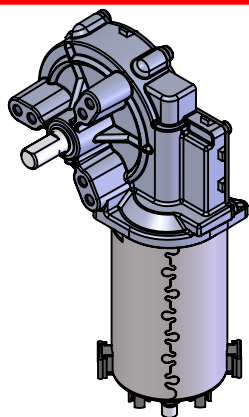

100502612

CARACTERÍSTICAS ELÉTRICAS	
U N (V)	13
P N (W)	25
n N (rpm)	29
I N (A)	5,5
I max (A)	23
M N (Nm)	8
M max (Nm)	49
I	55:1
Rotação	L / R
Peso (Kg)	1,700

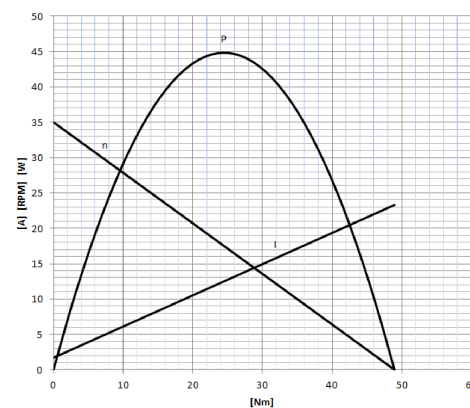

100502624

CARACTERÍSTICAS ELÉTRICAS	
U N (V)	27
P N (W)	28
n N (rpm)	30
I N (A)	2,7
I max (A)	10,5
M N (Nm)	8
M max (Nm)	50
I	55:1
Rotação	L / R
Peso (Kg)	1,700

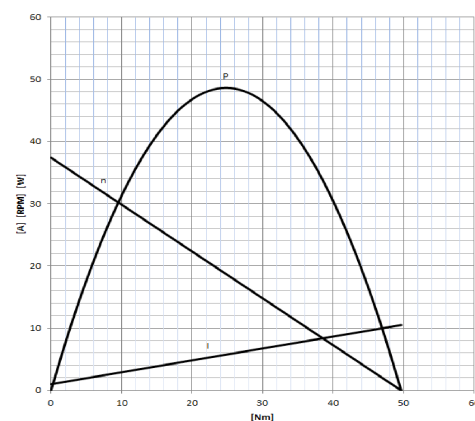

NOTAS:
Aplicação: Industrial

NOTES:
Application: Industrial